

DO NOT REPRODUCE
CONTACT CUSTOMER SUPPORT
1-800-906-4526

- NOTES:
- FOR DIMENSIONS AND TOLERANCES REFER TO CORRESPONDING DOOR PREPARATION DRAWING IP#.
 - FOR EXIT DEVICE AND MORTISE LOCK CUT-OUT REFER TO EXIT DEVICE MANUFACTURER INSTALLATION INSTRUCTIONS.
 - BACKSET SHOWN FOR REFERENCE ONLY, ADJUST BACKSET TO EXIT DEVICE MANUFACTURER INSTALLATION INSTRUCTIONS.
 - HOLES A: FROM THE INSIDE OF THE DOOR, DRILL HOLES (SEE TABLE)
 - SYMBOLS: - ∇ DEEP
- \ominus CENTER LINE OF DOOR
- \varnothing DIAMETER
- \rightarrow NOT TO SCALE
 - GROOVE TO DO ONLY ON SOLID DOORS. TO PASS WIRES INSIDE THE DOOR FOR HOLLOW DOORS.
 - ALL DIMS INCHES [mm]

HOLE ID	DIM INCH/(mm)	∇ INCH/(mm)	COMMENTS
A	$\varnothing 5/16$ (7,95)	$\nabla 3/4$ (19,05)	SEE NOTE #4
B	$\varnothing 1/2$ (12,7)	*	-
C	$\varnothing 1$ (25,4)	*	SEE NOTE #2
D	$\varnothing 3/4$ (19,05)	*	-
E	$\varnothing 3/4$ (19,05)	$\nabla 3/4$ (19,05)	-
F	$\varnothing 1/4$ (6,35)	$\nabla 1/4$ (6,35)	-
X	1/4 (6,35)	$\nabla 1/4$ (6,35)	SEE NOTE #6

* UNLESS OTHERWISE NOTED, DRILL HALF DOOR THICKNESS ON BOTH SIDES.

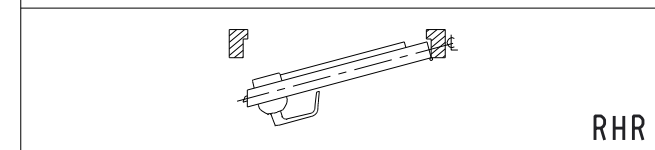
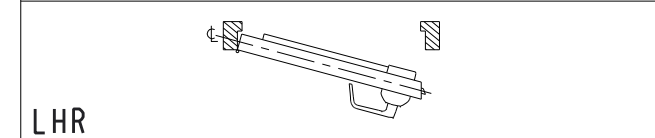

E7900 LOCK SERIES
DRILLING TEMPLATE
VON DUPRIN 9847/9947



www.kabalodgingsupport.com

SHEET 1 OF 2	DATE 24SE2018	UNE VERSION FRANCAISE DE CE DOCUMENT EST DISPONIBLE SUR DEMANDE.
	ECN 16871	DT-516412 REV-1

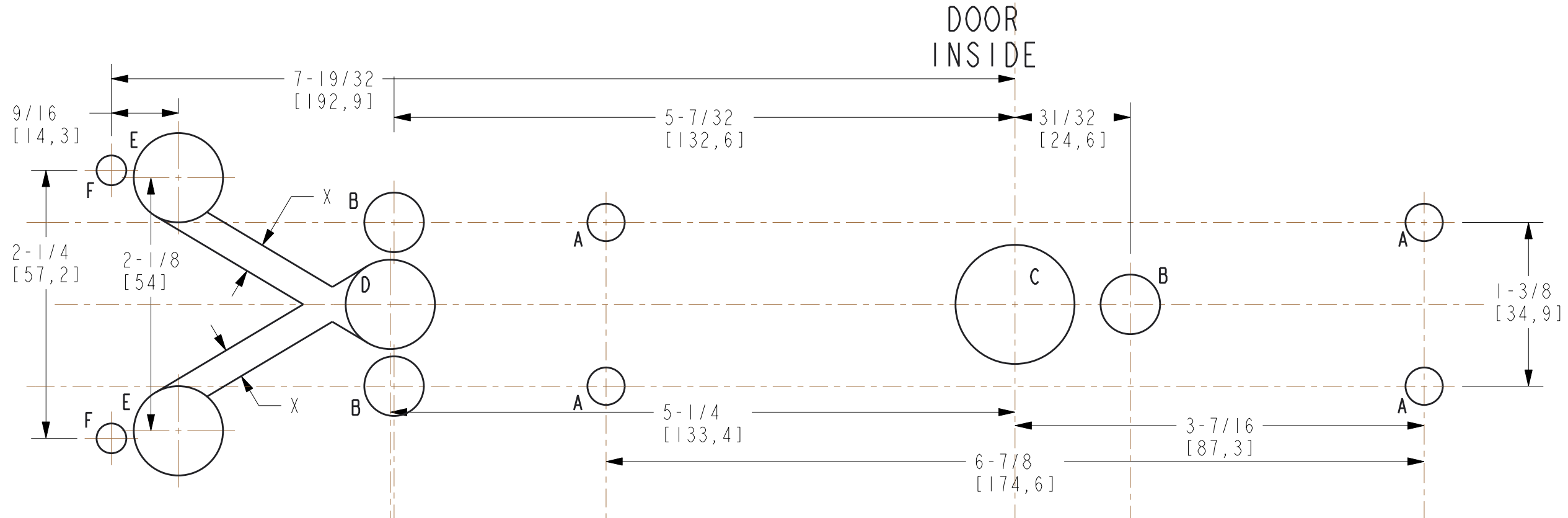
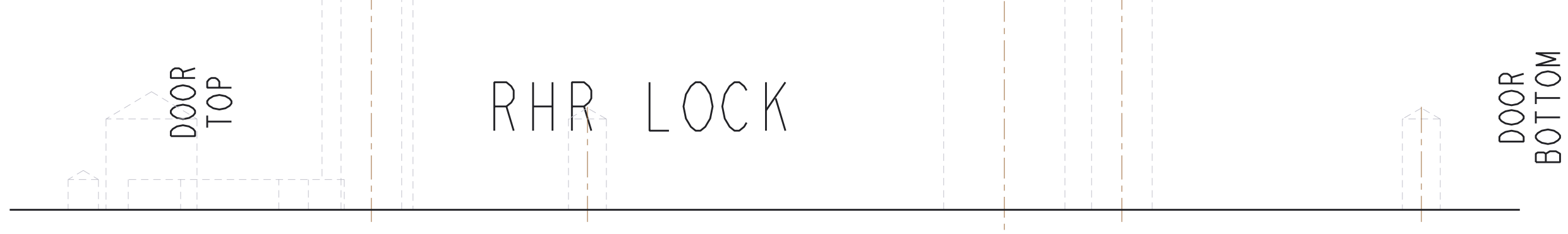
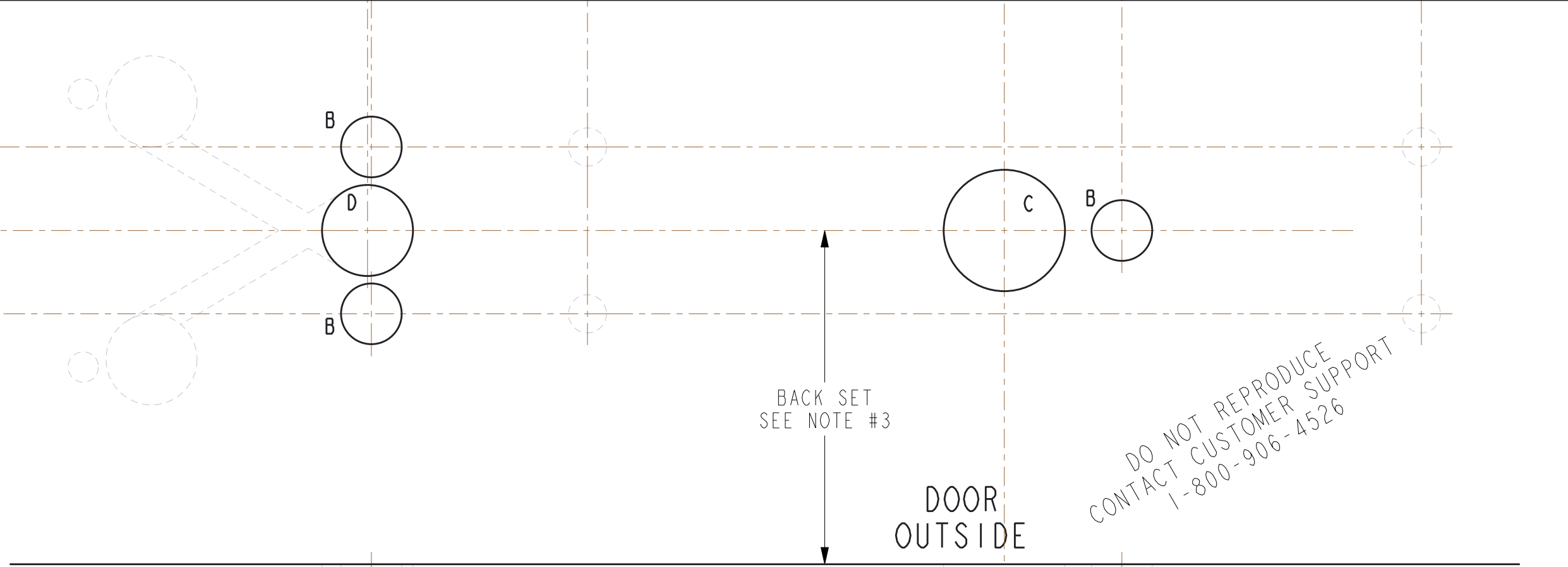

- NOTES:
- FOR DIMENSIONS AND TOLERANCES REFER TO CORRESPONDING DOOR PREPARATION DRAWING 1P#.
 - FOR EXIT DEVICE AND MORTISE LOCK CUT-OUT REFER TO EXIT DEVICE MANUFACTURER INSTALLATION INSTRUCTIONS.
 - BACKSET SHOWN FOR REFERENCE ONLY, ADJUST BACKSET TO EXIT DEVICE MANUFACTURER INSTALLATION INSTRUCTIONS.
 - HOLES A: FROM THE INSIDE OF THE DOOR, DRILL HOLES (SEE TABLE)
 - SYMBOLS:
 - ∇ DEEP
 - \oplus CENTER LINE OF DOOR
 - \emptyset DIAMETER
 - \rightarrow NOT TO SCALE
 - GROOVE TO DO ONLY ON SOLID DOORS. TO PASS WIRES INSIDE THE DOOR FOR HOLLOW DOORS.
 - ALL DIMS INCHES [mm]

HOLE ID	DIM INCH/(mm)	∇ INCH/(mm)	COMMENTS
A	$\emptyset 5/16$ (7,95)	$\nabla 3/4$ (19,05)	SEE NOTE #4
B	$\emptyset 1/2$ (12,7)	*	-
C	$\emptyset 1$ (25,4)	*	SEE NOTE #2
D	$\emptyset 3/4$ (19,05)	*	-
E	$\emptyset 3/4$ (19,05)	$\nabla 3/4$ (19,05)	-
F	$\emptyset 1/4$ (6,35)	$\nabla 1/4$ (6,35)	-
X	1/4 (6,35)	$\nabla 1/4$ (6,35)	SEE NOTE #6

* UNLESS OTHERWISE NOTED, DRILL HALF DOOR THICKNESS ON BOTH SIDES.

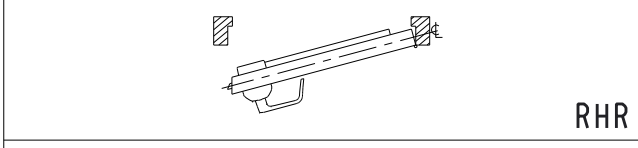
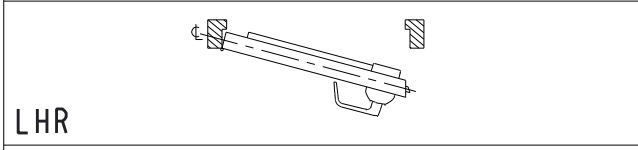

E7900 LOCK SERIES
 DRILLING TEMPLATE
 VON DUPRIN 9847/9947



www.kabalodgingsupport.com

SHEET 2 OF 2	DATE 24SE2018	UNE VERSION FRANCAISE DE CE DOCUMENT EST DISPONIBLE SUR DEMANDE.	
	ECN 16871	DT-516412	REV-1